

Ethernet based

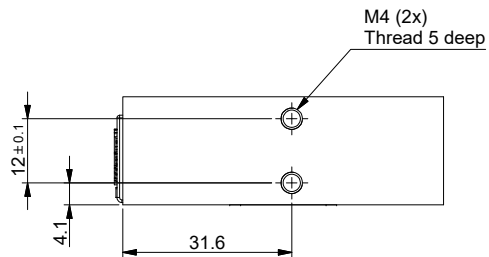
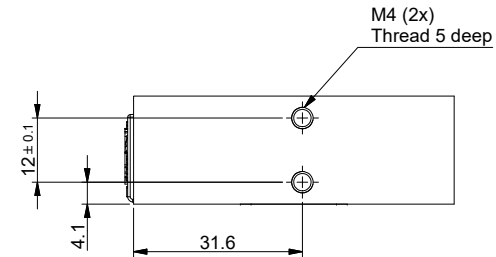
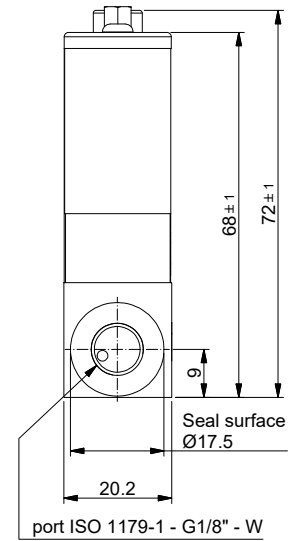
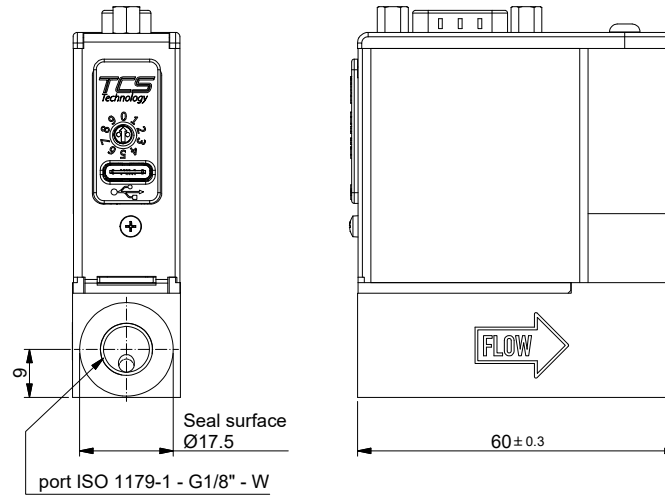
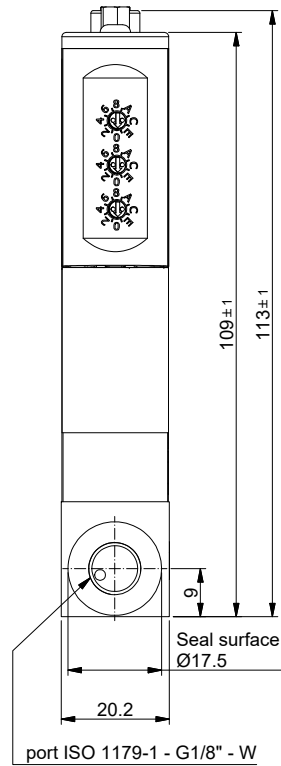
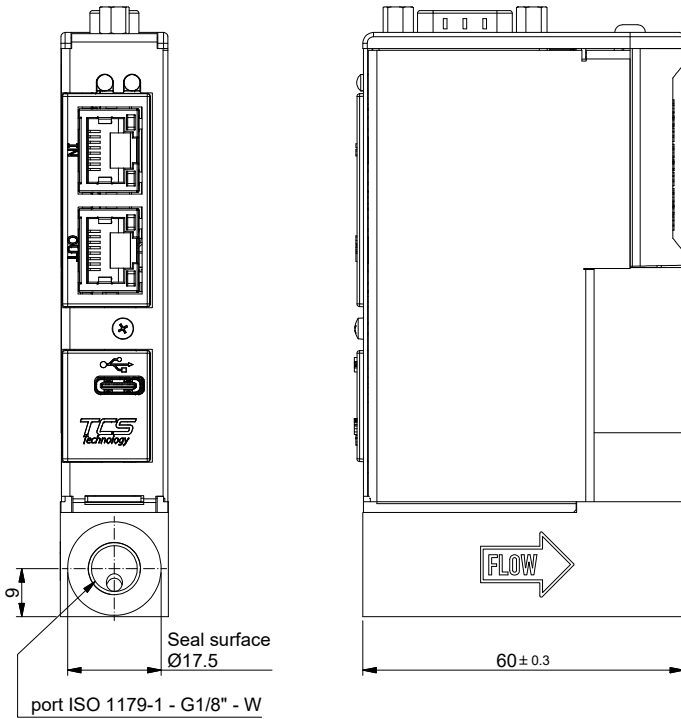
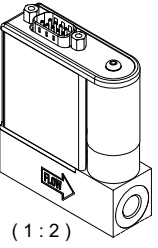
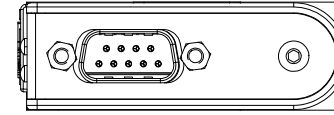
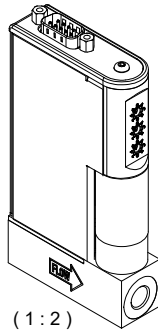
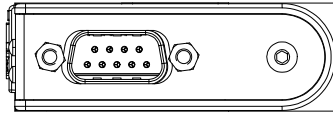

Dimensions subject to change without notice.

Tolerances ± 0.2 unless otherwise mentioned

Title: Dimensional drawing  
FLEXI-FLOW Compact FF-a1n



Projection:  
Third Angle  
Dimensions:  
Metric (mm)

Drawn by: M.H.  
Date: 28-01-2022  
Rev. by: M.H.  
Date: 19-09-2023  
Checked: V.H.  
Date: 19-09-2023

Revision Description:  
Ethernet based added.  
Title changed.

Scale:  
1 : 1  
A3

Drawing no.: 7.15.225

Rev: C  
Page: 1 - 1